





Cobalt α Alpha



Owners manual, range and application information for:





- Cobalt α Box
- Cobalt α Power
- Cobalt α Central
- Cobalt α Adapters
- Cobalt α Accessories

The Cobalt Alpha Range



Cobalt  Alpha - the core of the range: Cobalt  Alpha evolved from a desire to make the wiring of layouts easier for both DC and DCC modellers and the overall Alpha has quickly grown to include a wide group of products that simplifies control panel design and creation, greatly reduces the complexity of layout wiring and most importantly, allows both DC & DCC users to simplify control panel creation and easily add a digital accessory control bus.

By the way - while we have created Alpha  Switch as a companion product to make control panel creation quicker and simpler, traditional modellers do not have to change to use it! Cobalt  Alpha accepts ANY form of momentary switching as its control input, from Cobalt-S levers to push-button switches, "Stud & probe" ...and even diode matrix connections!



Cobalt  Switch and Accessories: These are the key to elegant yet very quick, easy to create, almost totally "soldering-free" control panels with unprecedented wiring simplicity. We are certain that every modeller can install Alpha  Switch as its all "plug and Play" - the wiring equivalent of building with Lego! Once you've created your panel the rest is easy too, as adding the Cobalt  Alpha control unit then reduces the need for "panel to layout" wiring to a single plug-in cable!

Cobalt  Box: Created to provide a versatile and almost totally "DCC brand independent" link between control panel, control system and operations, the super-versatile Cobalt  Box is the real key to seamless integration of the entire range. Cobalt  Box is many things and it does all of them well: It is the perfect power source for a DC modellers "Digital Accessory power bus" and the perfect interface between Cobalt  Alpha and any DCC Digital Accessory power bus.

It is a carefully crafted, conservatively rated 5-amp power booster with an on-off switch (most don't have one!) and it has sophisticated overload protection that gives both visual and audible warning of overload or short circuit.

In concert with Cobalt  Alpha, the Cobalt  Box is able to add high power and digital accessory control abilities to even the most basic of starter-sets and also enhances the system power and control versatility of full DCC systems of all brands.

Used alone Cobalt  Box is a versatile upgrade for every brand of DCC system -adding full 5amp power and system growth potential to basic low power "Train-set" systems, intermediate "Starter sets" or state of the art DCC-digital control systems.

Cobalt  Power: This is a high quality 5 amp regulated DC power supply with overload protection. As you know, a power supply that is properly matched to the systems it supplies is essential for achieving the best possible performance with digital devices, so while design-matched to Cobalt  Alpha and  Box, it's also a great choice for any 5 amp DCCsystem!

Cobalt Alpha manual - Table of Contents

- 3, 4, 5 *Introducing Cobalt Alpha Box, Cobalt Alpha Central, Cobalt Alpha & Cobalt Alpha Power: (Overview, connection details)*
- 6 *The "Unique control panel creator" option: Cobalt Alpha, plus Alpha-Switch etc. (With guide to connections and features)*
- 7 *Operating instructions for Alpha products. What the switches, buttons and other things do and when to use them!*

Especially for DC users who do not want to use DCC to drive their trains.

- 8 *Diagram 1 – General overview of ALPHA installations for DC users. Digital for DC!. Making wiring easier for DC users*

Especially for DCC users who have entry-level DCC-Starter sets.

- 9 *Diagram 2 – Alpha + Alpha Box – adding an ALPHA digital accessory bus AND connecting multiple ALPHA products*
- 10, 11 *Diagram 3 & 4 Alpha + Alpha Box – Overview - Simple system upgrade or full system expansion for ANY brand!*
- 12 *Diagram 5 – Alpha + Alpha Box – Detailed connection diagram for users of Bachmann EZ command DCC.*
- 13 *Diagram 6 – Alpha + Alpha Box – Detailed connection diagram for users of Hornby Select, Elite or E-Link DCC.*
- 14 *Diagram 7 – Alpha + Alpha Box – Detailed connection diagram for users of Gaugemaster (MRC) Prodigy Express.*

Especially for DCC users who have full-feature DCC starter sets or larger DCC systems.

- 15 *Diagram 8 – Alpha + Alpha Box – Add ALPHA Accessory control, protection and more power to NCE Power Cab.*
- 16 *Diagram 9 – Alpha + Alpha Box – Add ALPHA Accessory control, protection and more power to NCE Power Pro.*
- 17 *Diagram 10 – Alpha + Alpha Box – Add ALPHA Accessory control, protection and full power to LENZ systems.*
- 18 *Diagram 11 – Alpha + Alpha Box – Add ALPHA Accessory control, protection and full power to DIGITRAX systems.*
- 19 *Diagram 12 - Alpha + Alpha Box – Add ALPHA Accessory control, protection and full power to ESU EcOS.*
- 20 *Diagram 13 - Alpha + Alpha Box – Add ALPHA Accessory control, protection and full power to ROCO MAUS systems.*
- 21 *Diagram 14 - Alpha + Alpha Box – Add ALPHA Accessory control, protection and full power to Z21 systems.*
- 22 *Diagram 15 - Alpha + Alpha Box – Add ALPHA Accessory control, protection and full power to GM Prodigy systems.*
- 23 *Diagram 16 - Marrying tradition and Digital – using Alpha with Cobalt-S Levers.*

Additional information.

- 24, 25 *Tutorial – Building a control panel with ALPHA Switch. (Full photo-story, step by step)*
- 26 to 29 *Range info – Essential Alpha Accessory items. (Brand Interface adapters, Accessories, Control & Power devices)*
- 30 to 32 *Notes pages plus warranty and contact information.*



Cobalt α Box - the smartest booster available:

Cobalt α Box is an intelligent 5-amp power booster with excellent connection versatility and inter-brand operation.

Conceived to provide DC modellers with a digital accessory power bus & give DCC users the ability to create a separated accessory bus with its own power and independent overload protection, Cobalt α Box evolved to become an incredibly versatile "Intelligent booster", usable with any DCC system.

Cobalt α Box also offers users of entry-level or even very basic "Train-set Starter sets" real benefits: Like the ability to upgrade system power to 5 amps with high quality overload protection and, if used with Cobalt α or Cobalt α Central, it gives them the benefit of full digital Accessory control too.

Cobalt α Box has the following features.

- Sophisticated Aluminium case
- Blue "Power connected" indication within Logo
- Green illuminated "Power on" switch
- Red illuminated overload re-set switch
- Track bus \leftrightarrow Databus switch (On input side)

Cobalt α Box Input Connections are (left to right):

- Track power input (OK 0.05 to 5 amps track power)
- Main DCC system connection (RJ12 type)
- DCCsystem control / Cab bus connection (RJ12 type)
- Cobalt Alpha Connection (RJ12 type)
- DC power input socket (15~21v regulated DC)

Cobalt α Box Output Connections are (left to right):

- Alpha Bus / Cab bus Extension (RJ12 type)
- Track Power, 5 amps capacity, fully protected

Cobalt α Box - Pack contents:

- 1x Cobalt α Box
- 1x 6-wire 6' ~ 1.75m RJ12 to RJ12 curly cord
- 1x Instruction Manual

Cobalt α Box - You may also need the following items:

- 1x 5 amp regulated DC power supply. This should be Cobalt α Power or a good quality equivalent. (15~21v DC is OK, with a Coaxial DC plug to match α Box)
- Alpha Adapter cables especially for your DCC system. (note that NCE users do not need adapter leads)
- Cobalt α Panel, NCE UTP panel or your own brand "command bus interface panels" for the connection of additional handsets (only if you are extending the command bus for the connection of additional handsets)

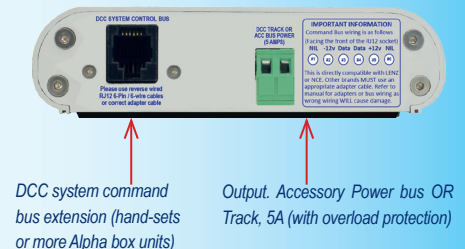
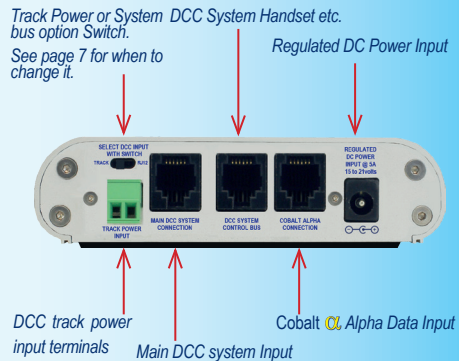

PLEASE NOTE: In some cases, the images used in this manual are of prototype or pre-production units and may vary slightly in appearance from those actually on sale. However in all cases all of the connections and diagrams are identical and the information given is correct.

Cobalt α Central

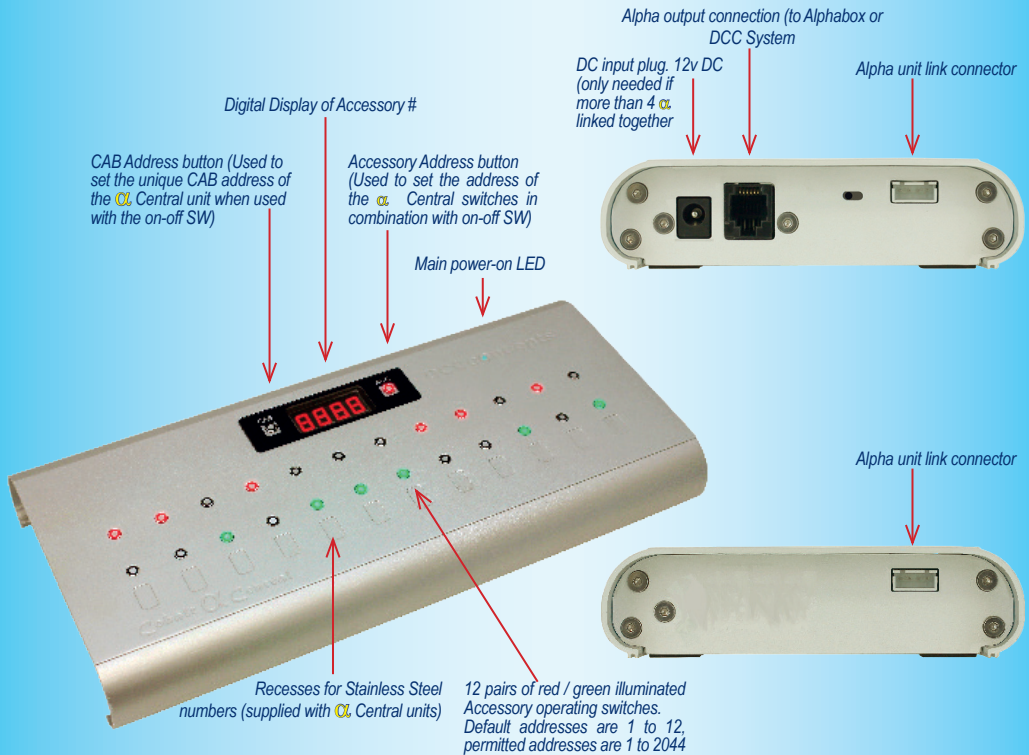

Cobalt α Central - Smart, Intelligent and the easiest control panel ever!

If we were to reduce the manual to its basics, it would read "open box, connect and operate"... it really can be that easy to have a sophisticated control panel if Cobalt α Central is involved! Link it to an intelligent Cobalt α box 5A Intelligent power booster and ANY modeller, DC or DCC can have an active digital accessory power bus up and running in no time at all.

Each Cobalt α Central controls 12 sets of switches and they can be combined and linked to give you control of more than 2000 digitally controlled points (Turnouts) or other DCC-compatible digital accessories. The possibilities are endless in fact!

Used with "train-set level" starter sets to add accessory control or with full DCC systems to add a control panel, Cobalt α Central & Cobalt α Box bring sophisticated accessory control to all - with only 1 cable needed to connect the entire panel!

Cobalt α Box - Pack contents:

- 1x Cobalt α Central
- 1x 6-wire 6' ~ 1.75m RJ12 to RJ12 curly cord
- 1x "Alpha Link" cable for joining multiple Cobalt α Central units together
- 1x Instruction Manual

Cobalt α Central - You may also need the following items:

- Most DCC brands and DC modellers: Cobalt Cobalt α Box, power supply for Cobalt α box.
- NCE PowerCab users can simply connect Cobalt α Central directly OR add the Cobalt α box to also increase output to 5 amps. NCE Power Pro users can just connect it to their system to add a 5 amp Accessory bus.

Cobalt α Power

figure 8 mains input, 100~260v AC (usable world wide)

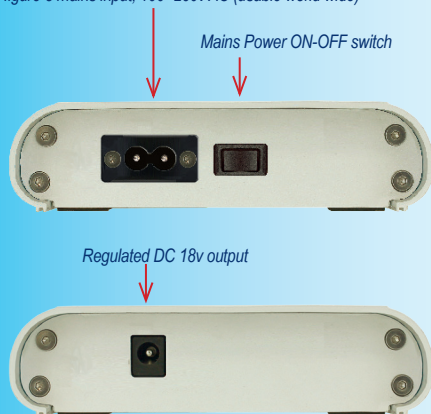

Overload reset Switch (hold for 3 seconds)

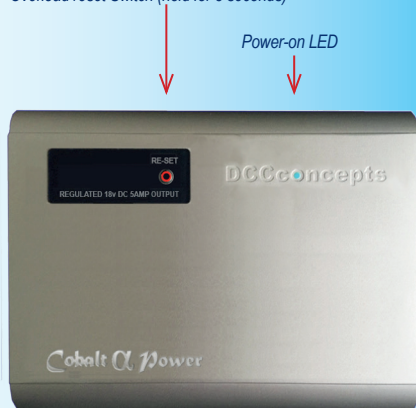

Cobalt α Power - Smooth well regulated power for perfect performance!

Its not commonly understood, but even those digital systems that show the use of AC power supplies in the manual actually run on DC internally... and what you may also not know is that while AC power supplies may be lower cost, they also give ZERO protection from inevitable voltage Surges and level changes, increasing the possibility of system damage!

So - using AC power makes little sense in reality - Especially as all involved in digital electronics agree that the quality of power supply that you choose will, more than any other factor, dictate the eventual performance of your model railway, because Digital electronics in particular require smooth, well filtered DC! Without it, interference added to the digital commands can at best cause problems with communication and may, in the extreme, actually damage your precious decoders and other items.

It just makes good sense to use a top quality, properly regulated DC power supply.

Cobalt α Power is a top quality, smoothly filtered and well regulated 5 amp output DC power supply that will deliver a smooth 18v at the input terminals of your DCC system, Cobalt α Central or similar digital device.

Using a different brand of control system or booster - it doesn't matter! While we have "design matched" Cobalt α Power to our Cobalt α range, it has also been tested with all main DCC brands from "Starter sets" to full-feature 5amp systems, and it consistently gives excellent results with all of those brands.

Cobalt α Power - Pack contents:

- 1x Cobalt α Power unit
- 1x Mains connection cord (Adapters for your country automatically supplied)
- 1x Power output connector with bare wire ends
- 1x Power output connector DC input plug for all Cobalt α products.
- 1x Instruction Manual

Linking the Cobalt α Range & creating a "Tilted Panel" look.

Cobalt α Central, Cobalt α Box and Cobalt α Power share a common case extrusion AND have recessed end plates to make it possible to link them together visually in-line and create a neat, tidy and professional look.

Also - If you look closely at the end profile of the extrusion you will also see a small vertical groove. This has been added to make it easy to "tilt" the units to make a sloping front panel. All you need to do is cut a length of 1.1~1.2mm alloy or plasticard to the width you want it to be and insert it into the groove to create the appearance you are looking for!

PLEASE NOTE: In some cases, the images used in this manual are of prototype or pre-production units and may vary slightly in appearance from those actually on sale. However in all cases all of the connections and diagrams are identical and the information given is correct.

Cobalt α Alpha

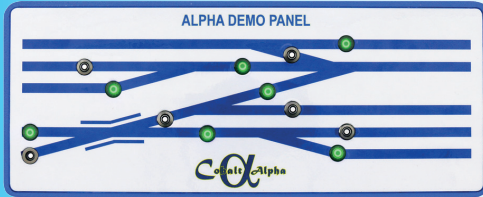

BUILD your panel with Alpha α Switch

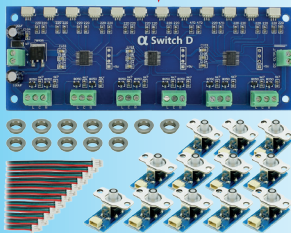

Connect Alpha α Switch to Cobalt α Alpha

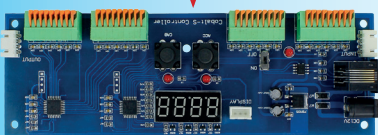

Connect Cobalt α Alpha to Alpha α Box



Connect Alpha α Box to the "Accessory Bus"

Creating Control panels with Cobalt α Alpha

For many DC or DCC modellers... creating a control panel has always been a complex job that few modellers really enjoy as it means lots of fiddly parts like LEDs, switches and the like, and inevitably, what seems like hundreds of wires that all need soldering... exactly, carefully and correctly.

Once that step is done comes the connection to the layout. many, many more wires, fiddly connectors and again, hours of soldering that you'll never know works until you plug it in! Cobalt α Alpha and its companion products, Alpha α Box and Alpha α Switch-D were created to fix this situation, once and for all - and to do it for ALL modellers, DC or DCC!

So how does using Cobalt α Alpha make it easier?

Step 1: Install an "Accessory power bus". That is just two wires that run around the layout passing all of the pointwork. We'll be delivering power down this wire, so please use 1mm² (14~16gauge) or greater wire diameter please!

Step 2: Fit all your points (turnouts) with accessory decoders and connect them to the Accessory power bus.

Step 3: Create your control panel design and install the switches from an Alpha α Switch-D pack - You can Choose between Red, Green or Blue illumination.

(We will show you just how easy this is to do in fine detail, with step by step pictures, on pages 24 and 25)

Step 4: Switch wiring has plugs on it! Just plug the switches into the Alpha α Switch-D Circuit board. (it is just as easy as assembling LEGO really - you cannot get it wrong)

Step 5: Using DCCconcepts DCD-RGB 3-wire ribbon cable, connect each output of the Alpha α Switch-D to the inputs of the Cobalt α Alpha unit.

Step 6: Using a 6-wire cable DCD-ACL or similar, connect the Cobalt α Alpha unit to Alpha α Box, or, if you are an NCE user, directly to the Powercab Panel or UTP Panel.

Step 7: Following the Cobalt α Alpha instructions, set the cab number for your Cobalt α Alpha, then set the switch numbering as needed (The default is 1~12)

Step 8: Following the instructions for your accessory decoders or digital turnout motors, set their address. In the case of DCCconcepts Cobalt motors or Accessory decoders, simply put their "Run / learn" switch into learn mode, press the button that you want to use to operate them and then return the switch to the run position.

It really is THAT Easy! No soldering at all, most parts are just plug and play it's a FAST process too! Usually, by utilising Cobalt α Alpha, the time taken to produce a professional control panel is reduced by 75% or more.

Please take a look at pages 24~25 to learn more!

PLEASE NOTE: In some cases, the images used in this manual are of prototype or pre-production units and may vary slightly in appearance from those actually on sale. However in all cases all of the connections and diagrams are identical and the information given is correct.



POWER SWITCH
PRESS to turn ON and OFF

RESET SWITCH.
It will light and flash if overload protection is activated. (The Alpha-Box unit will beep too)
PRESS and HOLD for 3 seconds to reset



TRACK POWER or SYSTEM BUS Selector Switch
Left position links track power out from a DCC system,
Right position is used for NCE PowerCab connection on first unit or any secondary Alpha-Boxes linked from Alpha-Box #1
(See specific diagrams for appropriate use of the switch)

MAIN SYSTEM CONNECTION.
6-Wire RJ12 connector. For connection to PowerCab OR secondary connection from other brand DCC system (To be used with the correct adapter leads only please)



RJ12 Control bus link.

Track power OUTPUT.

Track power INPUT.
Connect track power from ANY DCC system here.

Power Input 15-18v DC

Extend the DCC Control bus or link additional Cobalt Alpha boxes.

Track-Assessory Power bus with 5 amp power, protected

RJ12 DCC system control Bus.
NCE bus can connect directly, all other brands require Adapter leads

RJ12 CAB bus extension
NCE Cabs connect directly, other brands DO require Adapter leads



Alpha Alpha Central looks complex, but it is very easy to set up and use.

Incorporating one Cobalt Alpha control unit & the contents of two Alpha Switch-D packs, Alpha Central is the simplest way to create a professional control panel ever! Page 4 will show you a full set of Alpha Central features and related information. We have included initial connection, set-up and operating procedure here.

CONNECTION: Connect Alpha Central to the ALPHA input of your Alpha box using the RJ12 curly cord that we supply. (If you are an NCE user, you can just connect it directly to the NCE cab bus as both products use standard RS485 bus wiring conventions)

Setting the CAB bus number (Permitted range is 1 ~ 99): Alpha Central needs its own cab number as it is, in effect, the equivalent of a DCC handset. You can set it to any cab number within the allowable range for your DC system. Please make sure the number chosen is higher than the highest cab number already in use.

To do this, hold down the CAB button (see Image at right) as you turn your Alpha Central unit on. TWO digits will now flash.

Use momentary presses of the CAB button to choose which digit will be changed. Use momentary presses of the ACC button to change the value of the number. When you reach the number chosen, hold down the CAB button until the display flashes "YES". The cab number is now set.

Setting multiple Alpha Central unit CAB numbers: If you first link them together, then ALL units will be set simultaneously.

Setting the SWITCH numbers (Permitted range is 1 ~ 2044): The default is always 1~12, however this can be changed at any time. Setting the first switch number will set ALL of the numbers in sequence and if multiple Alpha Central units are connected, then ALL switches will be renumbered by setting switch 1 on unit 1.

To do this, hold down the ACC button (see Image at right) as you turn your Alpha Central unit on. FOUR digits will now flash.

Use momentary presses of the CAB button to choose which digit will be changed. Use momentary presses of the ACC button to change the value of the number. When you reach the number chosen, hold down the CAB button until the display flashes "YES". The Switching addresses of all linked units are now set.

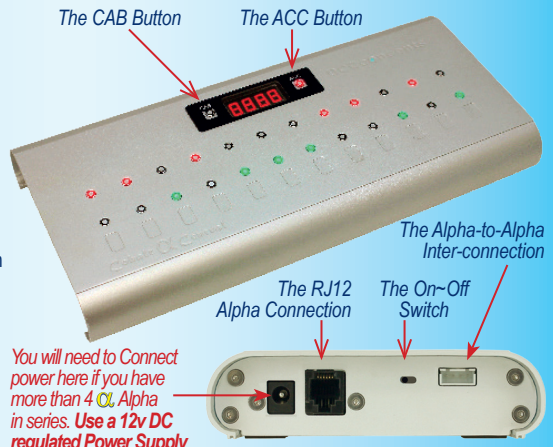

You will need to Connect power here if you have more than 4 Alpha in series. Use a 12v DC regulated Power Supply



Ideas for DC users who do NOT want to drive trains with DCC, but DO want to make wiring simpler, easier & improve accessory control.

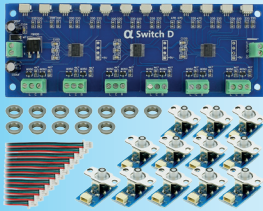
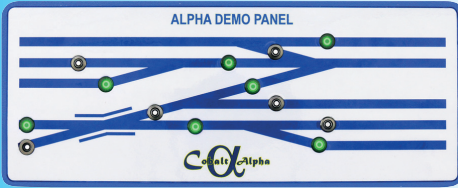

Choose either Cobalt α Alpha OR Cobalt α Central

STEP 1 - Choose how to create your control panel.

You can use conventional momentary switches, Stud and Probe or most other traditional methods - OR you could use the new Alpha α Switch-D range to make wiring exceptionally easy.

The next step is to connect the panel switching to Cobalt α Alpha Switch connections are a simple "Left-Common-Right" so they are very easy, and as Alpha α Switch-D uses screw terminals and there are simple "push terminals" on Cobalt α Alpha all you need is a small screwdriver and wire strippers/cutters!

Alternately, use Alpha α Central and your control panel will be ready to use the moment you unpack it and connect it to your layout... with no added complication at all.



STEP 2 - Connect the Cobalt α Alpha or Cobalt α Alpha Central unit to the Cobalt α Box

Alpha α Power
or 5-Amp Power
Supply 15~18v DC

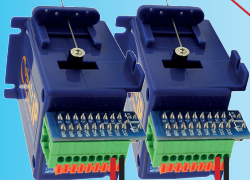

Just ONE Alpha α Box
Will power ALL of the Digital
Accessories you might use on
the largest of layouts!

STEP 3 - Create a DCC "Accessory Power Bus"

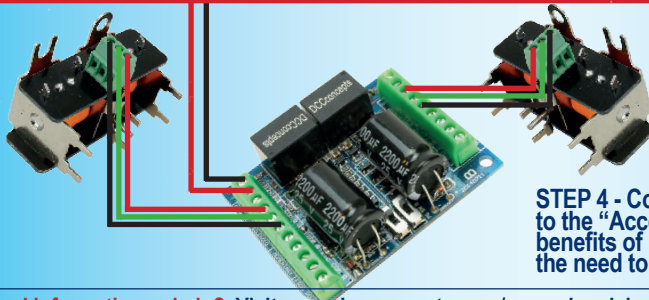

STEP 4 - Connect Digital Accessory decoders to the "Accessory Power Bus" and enjoy the benefits of Digital Accessory Control without the need to convert your Locomotives to DCC!

Cobalt Alpha & Cobalt Central

Create elegant control panels with only ONE cable needed for layout connection!

Of course, many layouts will need multiple Cobalt Alpha or Cobalt Central, all together or distributed around the layout, in order to control MANY Accessories. This is a simple process...

You can choose how its done. Several Units sharing one Cab number, all connected together in one place and joined with the link cable supplied, or several units distributed around the layout, each with its own "Cab" number and unique addresses..

Linking several units.

This is done using the cable supplied with each Alpha Unit.



Use 1, 2 or more Cobalt Alpha Central or Cobalt Alpha Central - it's up to you!

This diagram uses the NCE PowerCab which can connect directly as it uses the conventional RS485 connection structures. ALL other brands can also connect in a similar way with the help of adapter leads. (See individual brand diagrams)

You can choose how its done. You can also extend the control bus of your system by adding layout connection panels for the command bus at places marked (A) here. Please see the diagram covering your specific DCC system brand, or ask us if unsure.

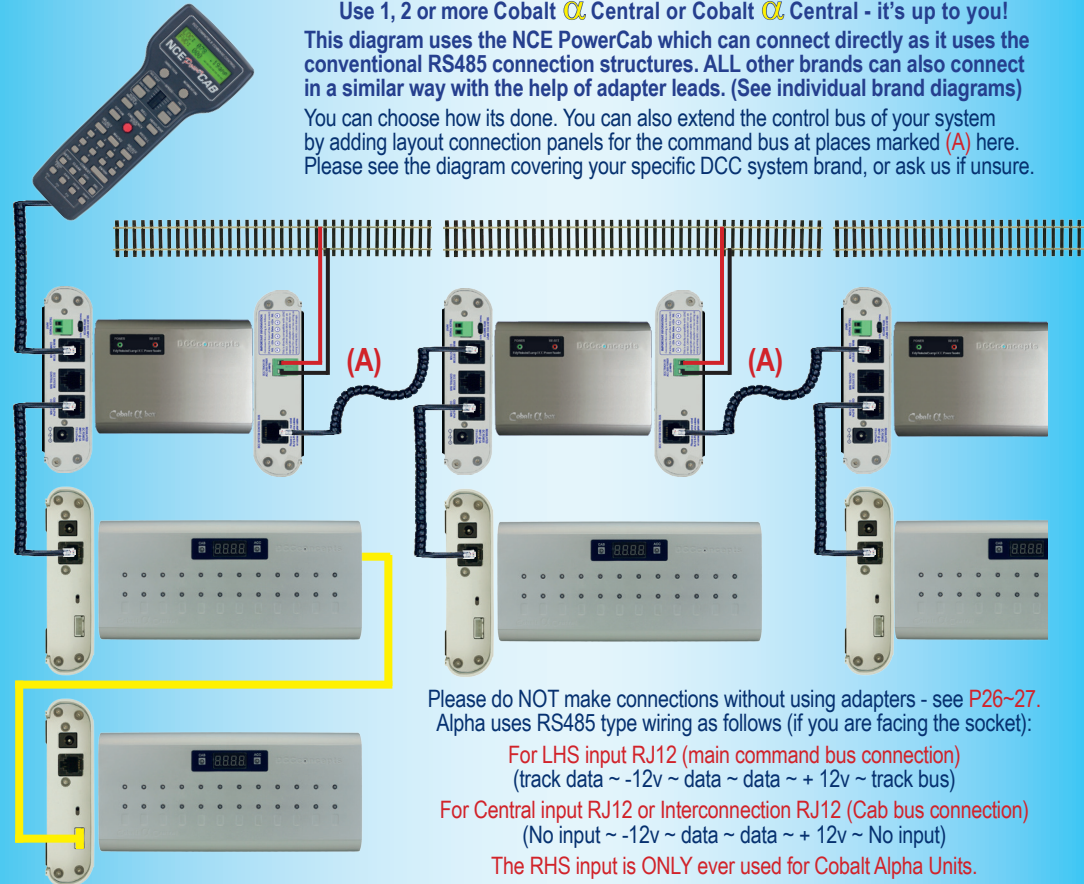

Please do NOT make connections without using adapters - see P26~27. Alpha uses RS485 type wiring as follows (if you are facing the socket):

For LHS input RJ12 (main command bus connection)
(track data ~ -12v ~ data ~ data ~ + 12v ~ track bus)

For Central input RJ12 or Interconnection RJ12 (Cab bus connection)
(No input ~ -12v ~ data ~ data ~ + 12v ~ No input)

The RHS input is ONLY ever used for Cobalt Alpha Units.



The easiest possible "Power & Performance" upgrade for every DCC system!

If you own a basic DCC system that came in the box with a "Train-Set" or perhaps purchased a basic low cost system to try out DCC operation - such as the easy-to-use but basic Bachmann EZ Command, Hornby Select or E-Link or Roco MAUS etc...

OR if you purchased a "White box" start-set Z21or a Gaugemaster Prodigy Express but now want Accessory control...

OR if you just want more power from your DCC system and perhaps like the idea of a separated Cobalt Alpha - based Accessory power bus - then you really DO need Cobalt Alpha Box!

This diagram shows how easy it is to add Alpha Box to ANY DCC SYSTEM AT ALL. Brand-by-Brand diagrammes follow



PLEASE NOTE: In some cases, the images used in this manual are of prototype or pre-production units and may vary slightly in appearance from those actually on sale. However in all cases all of the connections and diagrams are identical and the information given is correct.



Using multiple Cobalt Alpha Box for separated Accessory bus & Power Districts!

If you like the idea of a separated DCC Track bus and Accessory power bus - or if you have a larger layout that might benefit from separate power districts, each with its own power booster and overload protection, then Cobalt Alpha Box will do it for you, no matter which brand you use!

This diagram shows how to add an Accessory power bus or multiple power districts using Alpha Alpha Box.

Subject to the use of the correct adapter leads (see page 26~27) this will work with ANY DCC SYSTEM AT ALL..

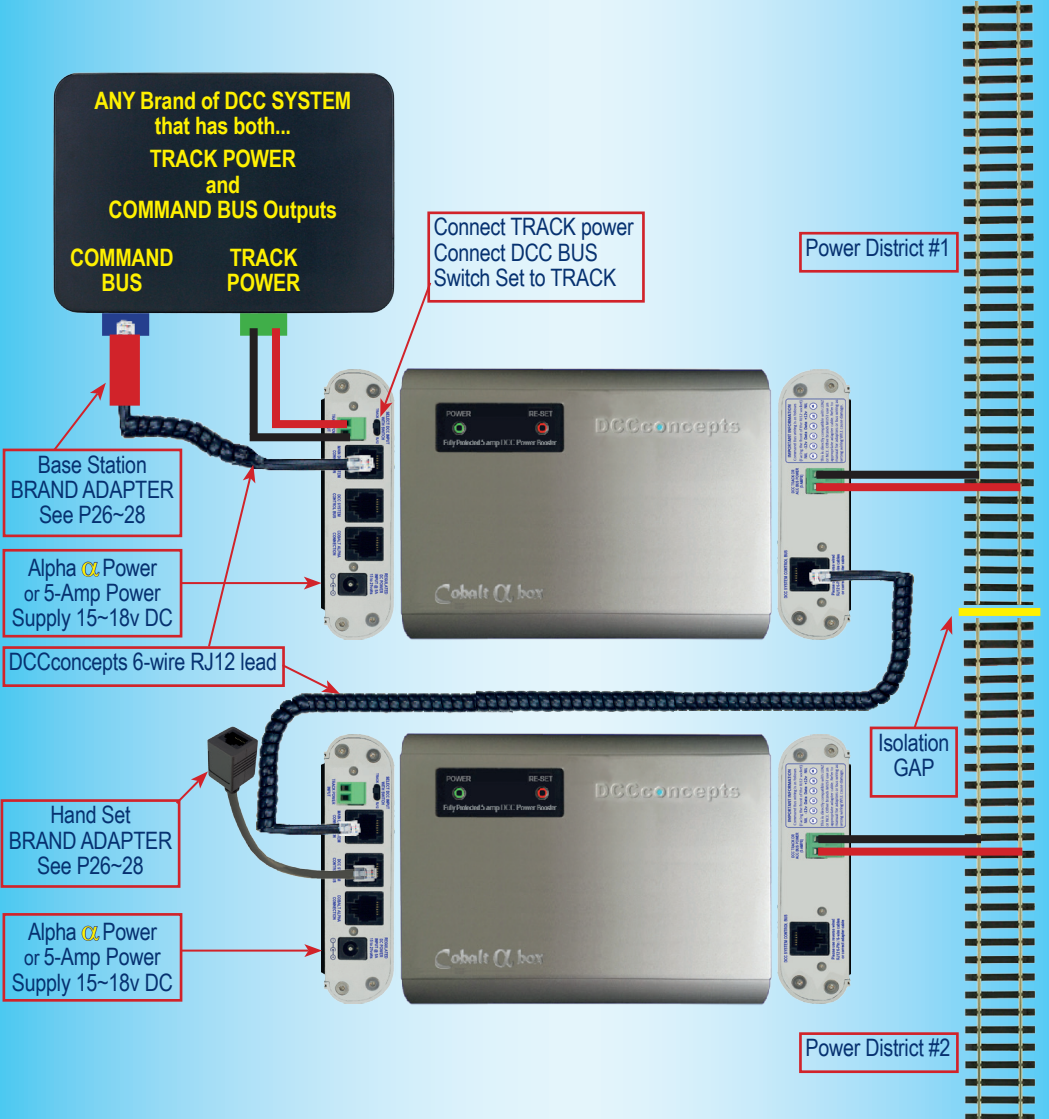

Upgrading Bachmann E-Z COMMAND®

The Bachmann E-Z Command® is a nice quality but very basic DCCcontrol system designed for “train-set” inclusion, so, in order to keep costs low, both its functionality and its power output are limited. Because of this, many are relegated to the bottom drawer soon after purchase.

E-Z Command® does meet all relevant DCC standards and some owners like its “very simple to use” interface, but it has not been easy to upgrade and add features that really ARE needed!

However - We can now offer a solution: In fact it is VERY easy to upgrade E-Z Command's very low power output with Cobalt Alpha Box and we can easily add full digital Accessory control by using Cobalt Alpha or Cobalt Central, Giving your DCC system much greater abilities!

Here is how to do it, connection by connection...

PS: This is a ZERO waste upgrade too, because if you change brand later, your Cobalt Alpha Box, Cobalt Alpha or Cobalt Central will all still work perfectly with it!



Connect any kind of DCC Accessories to your new track bus and control them with

Cobalt Alpha
or
Alpha Central

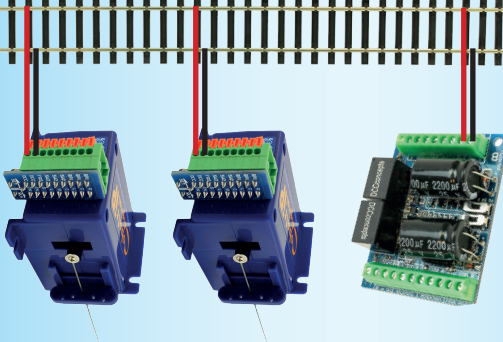

SIMPLE ISN'T IT

Just a couple of connections and you have upgraded to a full 5 amps track power, with full overload protection...

...and you have easy to use "Digital Accessory Control" too!

Upgrading Hornby Elite, Select, E-Link

Select and E-link are often found in “Digital Train-sets” and the Elite has been adopted by many Hornby oriented modellers, however accessory control can be clumsy and the overall output power is quite limited, particularly with Select and E-link.

Fortunately for those who like using these products it is VERY easy to upgrade the low power output with Cobalt α Box and for those who want a more convenient “single push control” for Accessories, we can easily add full digital Accessory control by using Cobalt α Alpha or Cobalt α Central, giving your DCC system much greater convenience and usability!

Here is how to do it, connection by connection...

PS: This is a ZERO waste upgrade too, because no matter which brand you may move to later, Cobalt α Box, Cobalt α Alpha or Cobalt α Central will all work perfectly with it!

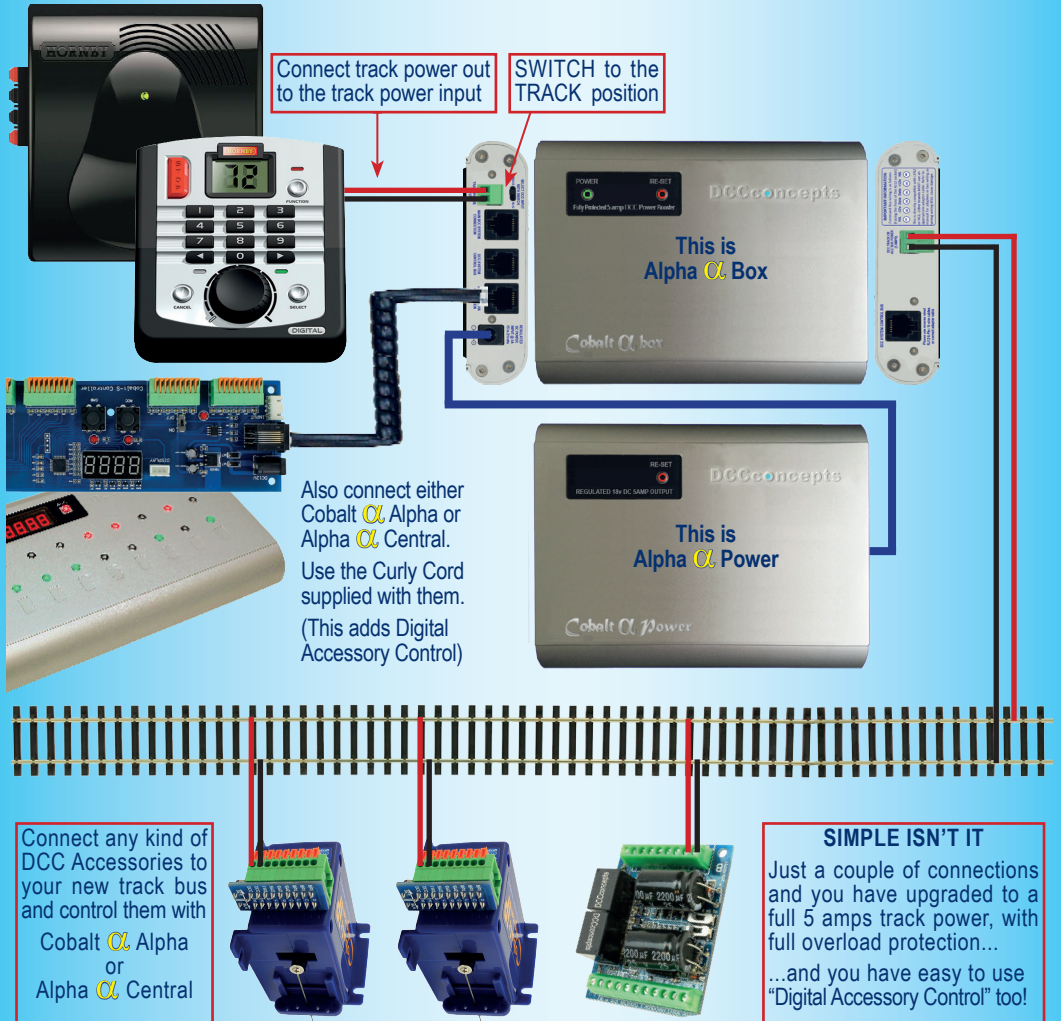

PLEASE NOTE: In some cases, the images used in this manual are of prototype or pre-production units and may vary slightly in appearance from those actually on sale. However in all cases all of the connections and diagrams are identical and the information given is correct.

Upgrade Gaugemaster Prodigy Express

The Gaugemaster Prodigy Express is based on the full power Prodigy but deletes some of its functionality (Accessory control). It also has much lower power power output, so an upgrade that will increase its abilities in these areas will be welcomed by many.

As with other entry level sets, adding more power and easy-to-use accessory control with Cobalt α Box, plus Cobalt α Alpha or Cobalt α Central is worthwhile - and VERY easy to do. Here is how to do it, connection by connection...

PS: This is a ZERO waste upgrade too, because if you change brand later, your Cobalt α Box, Cobalt α Alpha or Cobalt α Central will all still work perfectly with it!



Connect any kind of DCC Accessories to your new track bus and control them with

Cobalt α Alpha
or
Alpha α Central

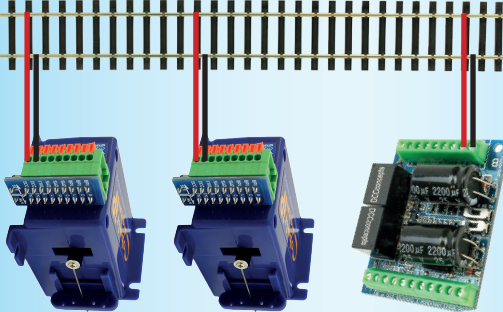

You CAN also extend the Control/ DCC Data bus!

If you have a Prodigy Express and want to add a Control bus using the RJ45 sockets then you can. Please use the advice on Page 22 for Gaugemaster Prodigy.

Upgrade the NCE PowerCab Starter Set

The NCE PowerCab is perhaps the most complete or all of the “Starter Sets” and is therefore really popular, however it has extremely limited overload protection so can easily be damaged by low level short-circuits left active for too long and it soon outgrows the average modellers needs for layout power as its true output power ability is really only 1.5 amps continuous.

We COULD simply connect the PowerCab panel to the system as per the Prodigy Express, but as the PowerCab uses the same wiring as Cobalt α Box, we can be more adventurous and really make something special with the NCE PowerCab + Cobalt α Box combination!

All “Curly Cords” DCCconcepts are 6-wire RJ12 # DCD-ACL



Move the SWITCH to the RJ12 position

Direct Connections with NO need for Adapters makes this a Super-versatile addition to PowerCab “Power & potential”

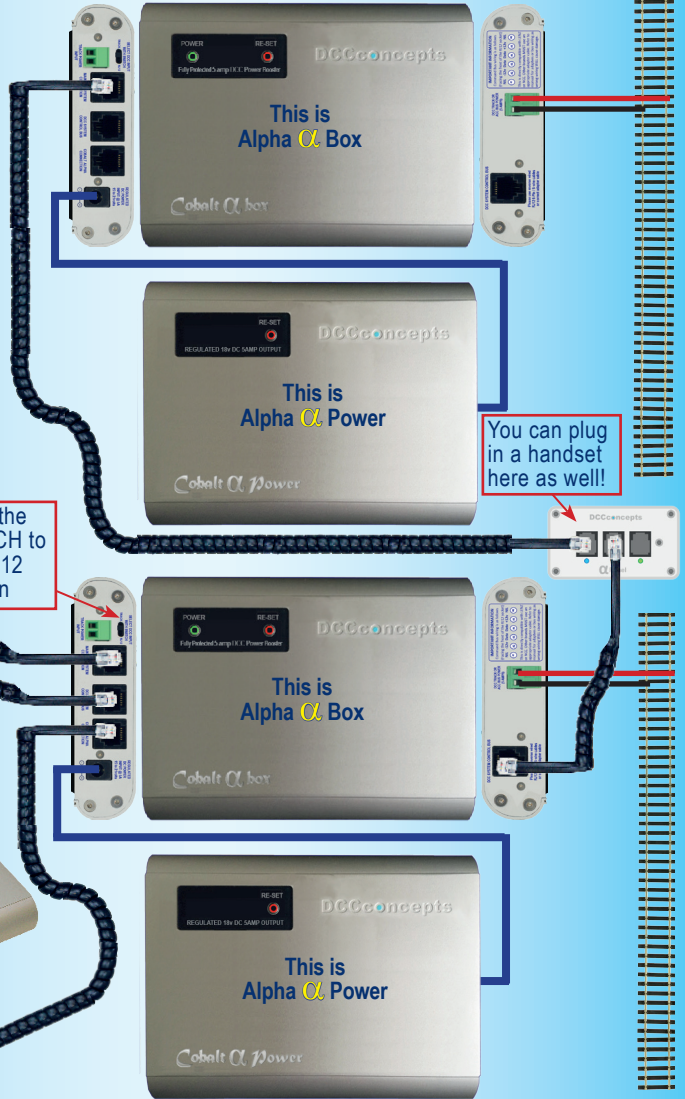

PLEASE NOTE: In some cases, the images used in this manual are of prototype or pre-production units and may vary slightly in appearance from those actually on sale. However in all cases all of the connections and diagrams are identical and the information given is correct.

Add ALPHA + Power to NCE POWER PRO

The NCE Powerhouse Pro is a versatile system and very popular, however it too can be added to and increased in potential if combined with Cobalt α Box for added power and Cobalt α Alpha or Cobalt α Central for control panel sophistication.

As with PowerCab, the similar Bus wiring allows integration with no adapter leads - however using the correct leads DOES matter.

Please use ONLY 6-wire DCD-ACL Curly Cords as supplied with Alpha units by DCCconcepts as links between Alpha Box units and for Alpha Central, or some of the features may not be available (You can use the NCE supplied 4-wire leads for Cab Connection)!

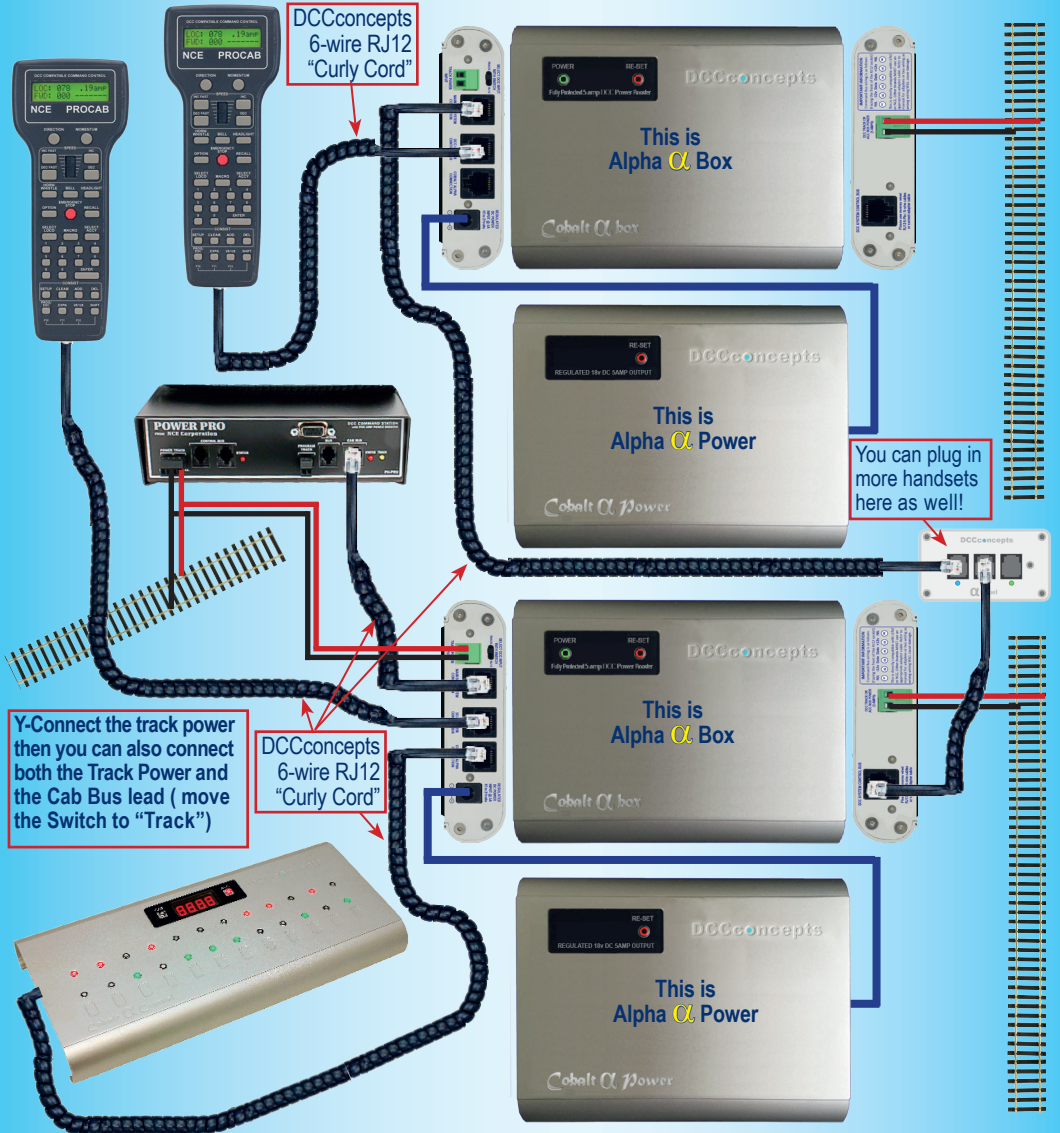

Upgrade any of the **LENZ** DCC Systems

If you like the idea of a separated DCC Track bus and Accessory power bus - or if you have a larger layout that might benefit from separate power districts, each with its own power booster and overload protection, then Cobalt α Box will do it for you, no matter which brand you use!

This simple diagram shows how to add an accessory power bus or multiple power districts to LENZ using Alpha α Box. LENZ users can actually have the same sort of versatility with ALPHA products as NCE, as the LENZ bus is actually very similar. Therefore, subject to the use of the correct LENZ adapter leads, you can either use LENZ LA152 adapter plates OR Alpha Panel with Lenz Adapter as additional handset connection points. There really is NO limit to the system growth that is possible with Alpha α Box as long as you utilise our adapter leads too (see page 26-27).

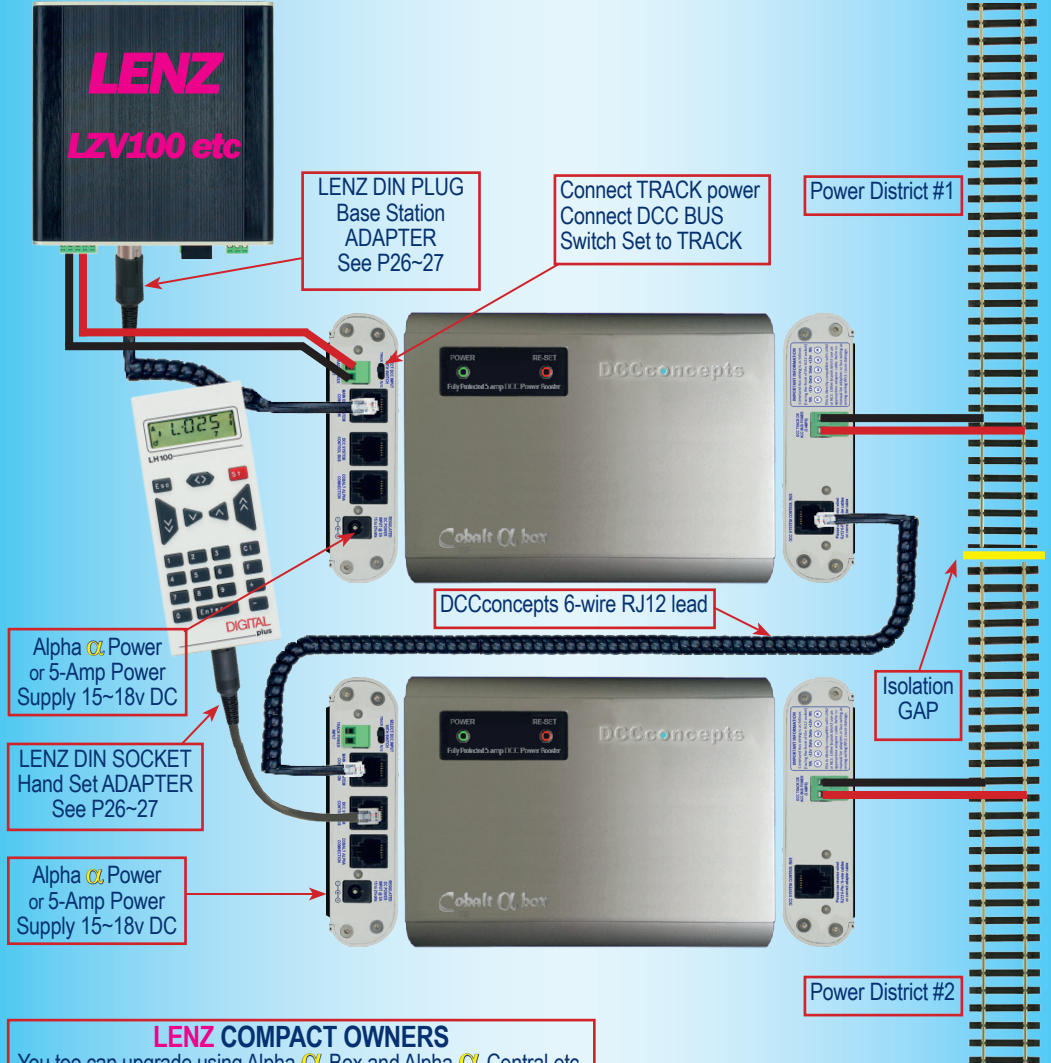

PLEASE NOTE: In some cases, the images used in this manual are of prototype or pre-production units and may vary slightly in appearance from those actually on sale. However in all cases all of the connections and diagrams are identical and the information given is correct.

Upgrade your **DIGITRAX** DCC System

As your layout grows the benefits of separated DCC power districts and a separate accessory power bus become more important. If you have a Digitrax system, whether it is a Zephyr, a Super-Chief or any other, then Cobalt α Box will do it all for you!

This simple diagram shows how to add an accessory power bus or power districts to DIGITRAX using Alpha α Box.

Digitrax actually uses quite a different power bus wiring structure, however we made Alpha very versatile, so you still have lots of possibilities, subject only to the use of the correct DIGITRAX adapter leads. There really is NO limit to the system growth that is possible with Alpha α Box as long as you utilise our DIGITRAX adapter leads too (see page 26~27).

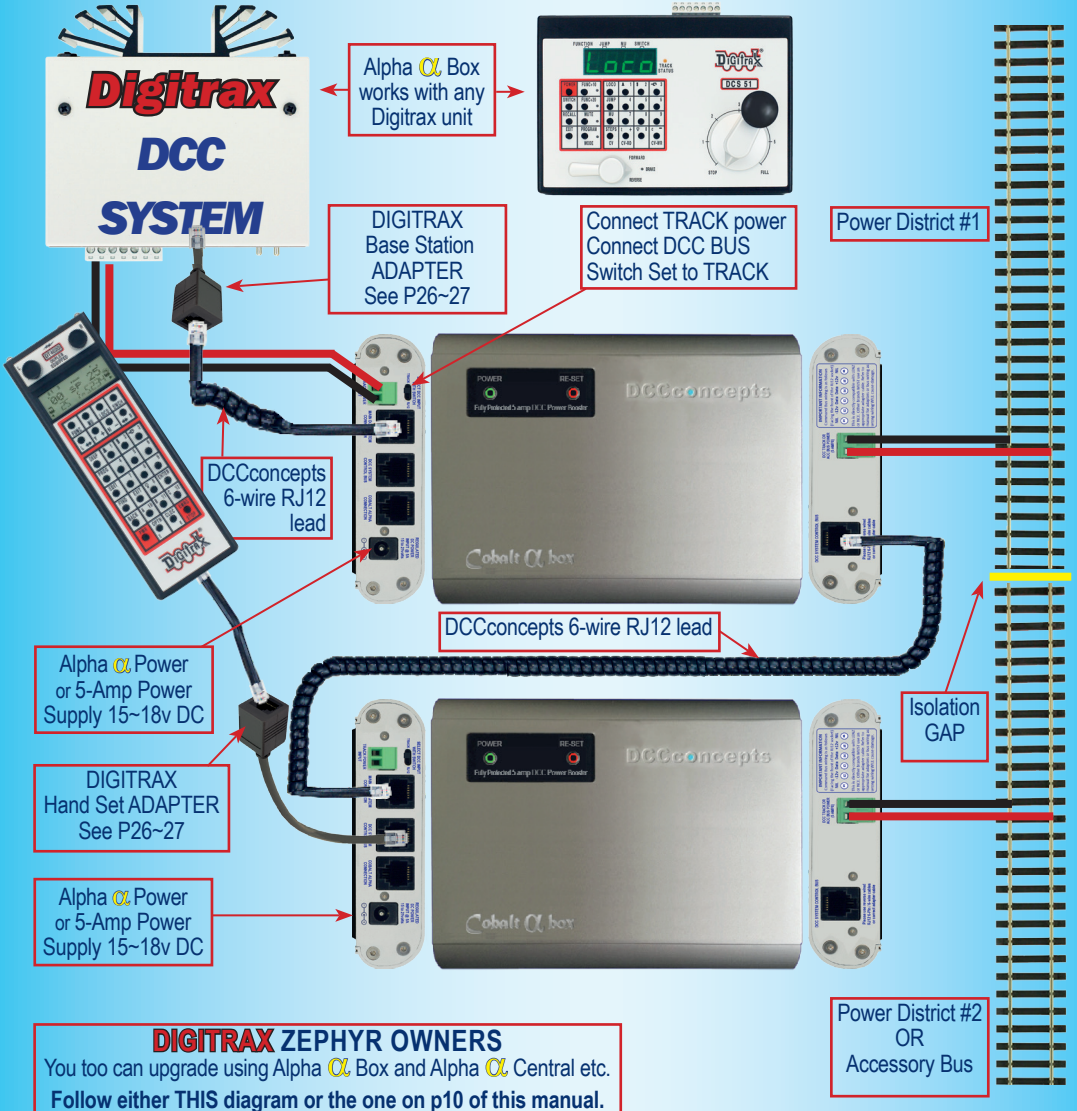

PLEASE NOTE: In some cases, the images used in this manual are of prototype or pre-production units and may vary slightly in appearance from those actually on sale. However in all cases all of the connections and diagrams are identical and the information given is correct.

adding ALPHA to the ESU ECoS System

If you like the idea of a separated DCC Track bus and Accessory power bus - or if you have a larger layout that might benefit from separate power districts, each with its own power booster and overload protection, then Cobalt α Box will do it for you, no matter which brand you use!

This simple diagram shows the most BASIC way to add an accessory power bus or multiple power districts to your ESU ECoS system by utilising Alpha α Box. It also shows the addition of Alpha α Central or Cobalt α Alpha. As ECoS uses CANbus and not RS485 based structure, direct bus linking is not possible, however Alpha α box can still be linked via the 6-wire RJ2 bus for transmission of Alpha α Central or Cobalt α Alpha Commands and of course "Power District" structures.



Upgrade the **ROCO** MultiMaus Systems

ROCO DCC is popular as it's often sold in "Start Sets"... There have been several series of ROCO systems however connections are fortunately very similar in all cases. So, if you are a ROCO user, adding Cobalt Alpha or Cobalt Alpha Central is easy... giving you the benefit of really nice control panels and Cobalt Box will add lots of power PLUS improved overload protection.

This simple diagram shows how to add an accessory power bus or multiple power districts to ROCO using Alpha Box. ROCO users can connect via X-bus and so actually have the same sort of versatility with ALPHA products as Lenz, as the LENZ & ROCO bus are actually very similar. Use the correct adapter leads, and there really is NO limit to what is possible with ROCO and DCCconcepts Alpha Products! (see page 26-27).

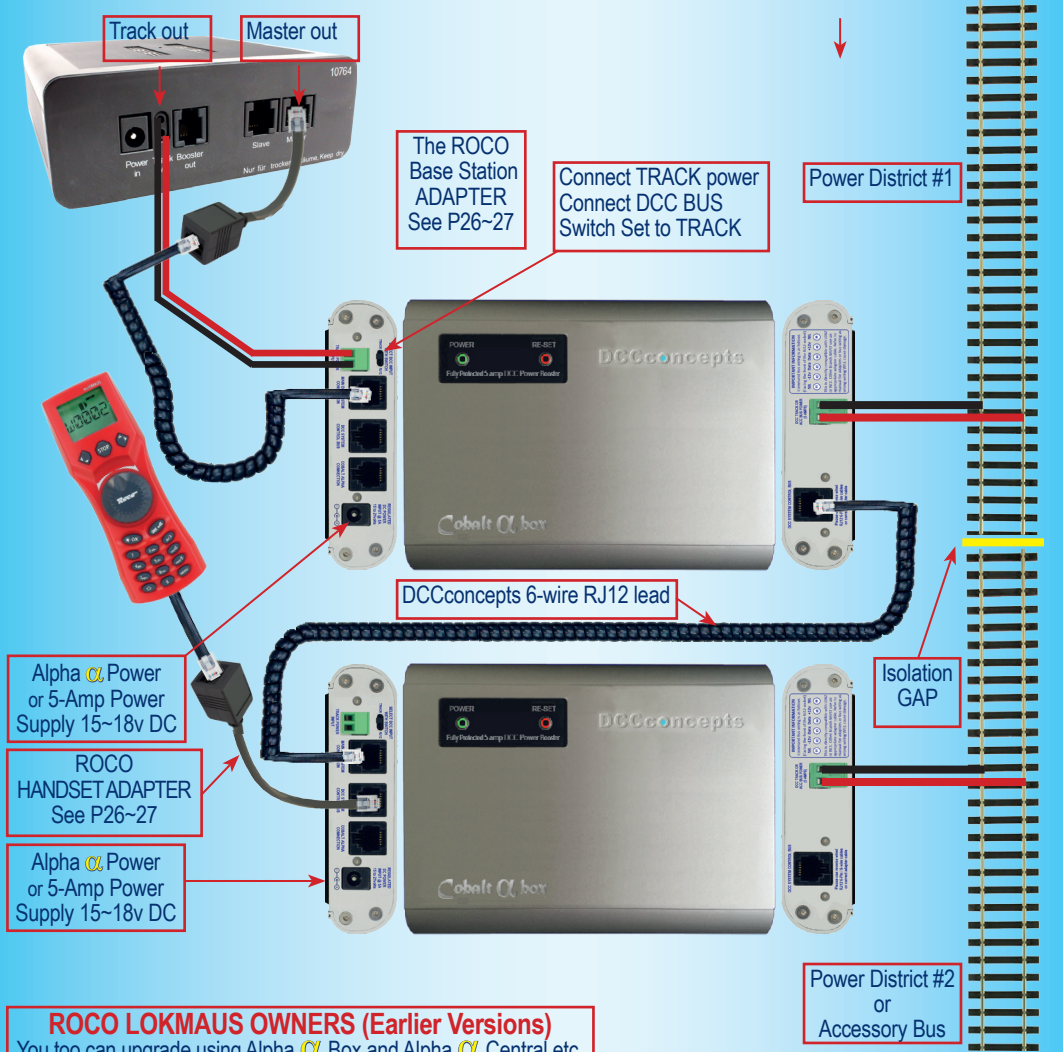

- Alpha Alpha Power or 5-Amp Power Supply 15~18v DC
- ROCO HANDSET ADAPTER See P26~27
- Alpha Alpha Power or 5-Amp Power Supply 15~18v DC

ROCO LOKMAUS OWNERS (Earlier Versions)
 You too can upgrade using Alpha Alpha Box and Alpha Alpha Central etc.
 Just use the diagrams on page 10/11/12/13 of this manual.

Upgrade any of the **ROCO** Z-21 Systems

The ROCO on-screen App-Based Z21 is sold in two versions, however connections are almost identical. Roco chose to use an X-bus type RJ12 connector making it similar to LENZ and so it is good to work with. As a result, if you are a ROCO Z21 user adding Cobalt α Alpha or Cobalt Alpha α Central is easy... giving you the benefit of really nice physical control panels and Cobalt α Box will add lots of power (66% greater power than Z21) PLUS improved overload protection.

This simple diagram shows how to add an accessory power bus or multiple power districts to ROCO using Alpha α Box. ROCO users can connect via X-bus and so actually have the same sort of versatility with ALPHA products as Lenz, as the LENZ & ROCO bus are actually very similar. Use the correct adapter leads, and there really is NO limit to what is possible with ROCO and DCCconcepts Alpha α Products! (see page 26-27).

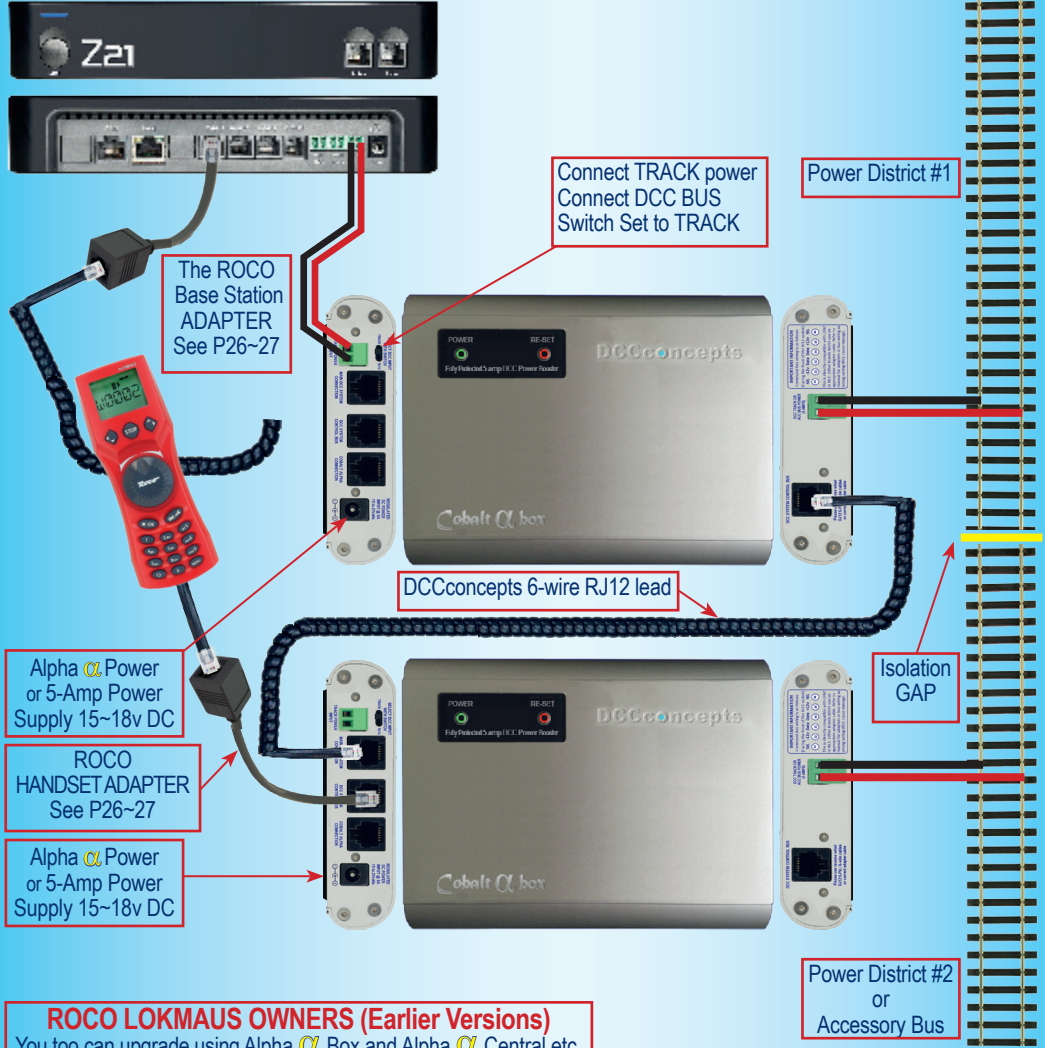

ROCO LOKMAUS OWNERS (Earlier Versions)
 You too can upgrade using Alpha α Box and Alpha α Central etc.
Just use the diagrams on page 10/11/12/13 of this manual.

PLEASE NOTE: In some cases, the images used in this manual are of prototype or pre-production units and may vary slightly in appearance from those actually on sale. However in all cases all of the connections and diagrams are identical and the information given is correct.

Upgrade the Gaugemaster Prodigy

The Gaugemaster Prodigy and MRC Prodigy connect the same way - so follow this diagram for either brand. While basically an RS485 bus similar to Lenz or NCE, The makers of Prodigy and the Prodigy Express use RJ45 connections - however DCCconcepts have created adapter leads for use with these products. Please see page 26~27. Using the adapters makes it easy...

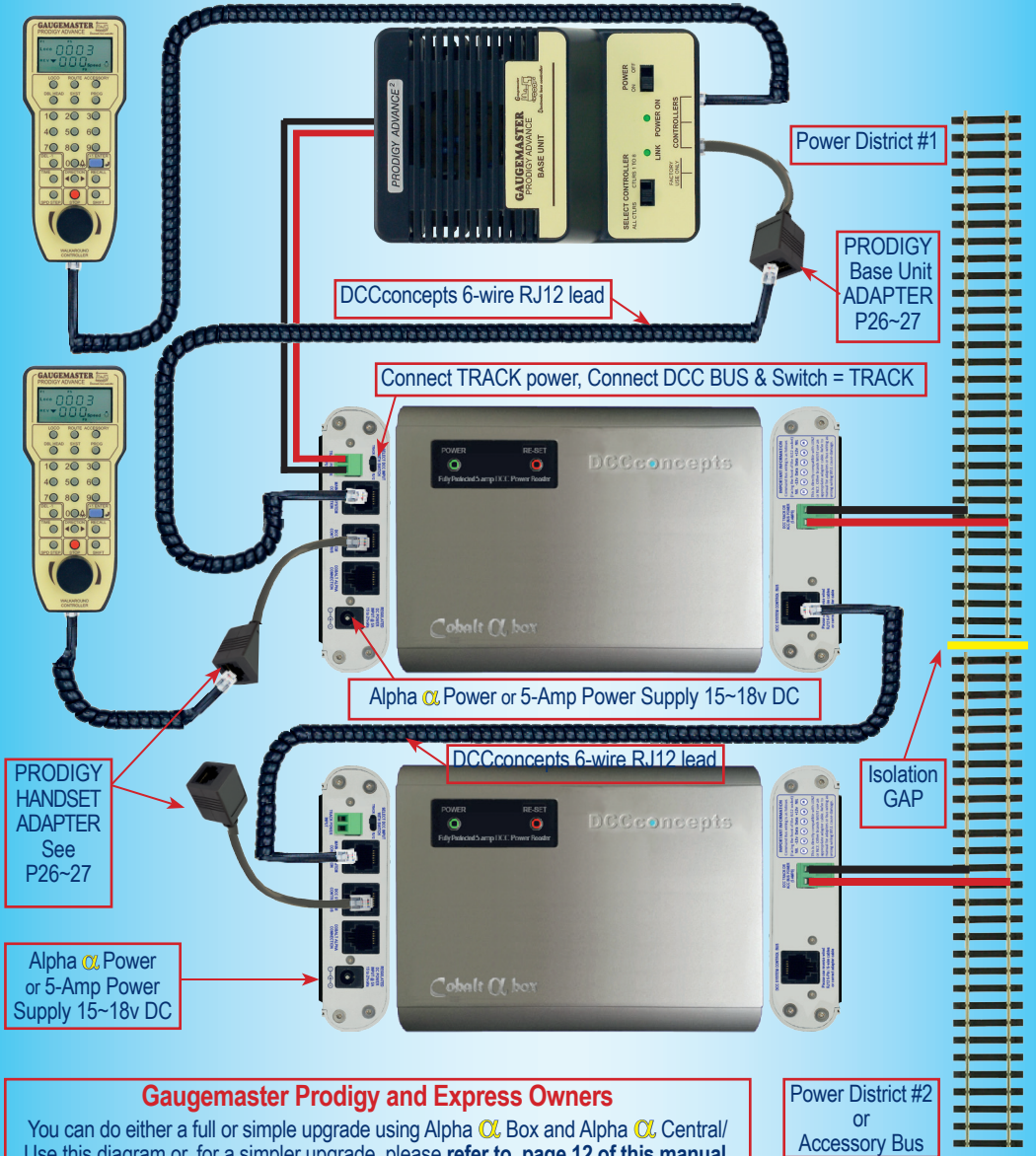

Gaugemaster Prodigy and Express Owners
 You can do either a full or simple upgrade using Alpha α Box and Alpha α Central/
 Use this diagram or, for a simpler upgrade, please refer to **page 12** of this manual.

Power District #2
 or
 Accessory Bus

PLEASE NOTE: In some cases, the images used in this manual are of prototype or pre-production units and may vary slightly in appearance from those actually on sale. However in all cases all of the connections and diagrams are identical and the information given is correct.

Using Cobalt α Alpha & Cobalt-S Levers

Cobalt-S Levers bring a touch of “Traditional Signal-box” operation to your model railway while Cobalt α Alpha adds the magic of digital technology to greatly reduce wiring... So a combination of these two great products gives the best of both worlds, resulting in a realistic “Feel” for layout control needing only ONE cable to connect all those wires to the layout!

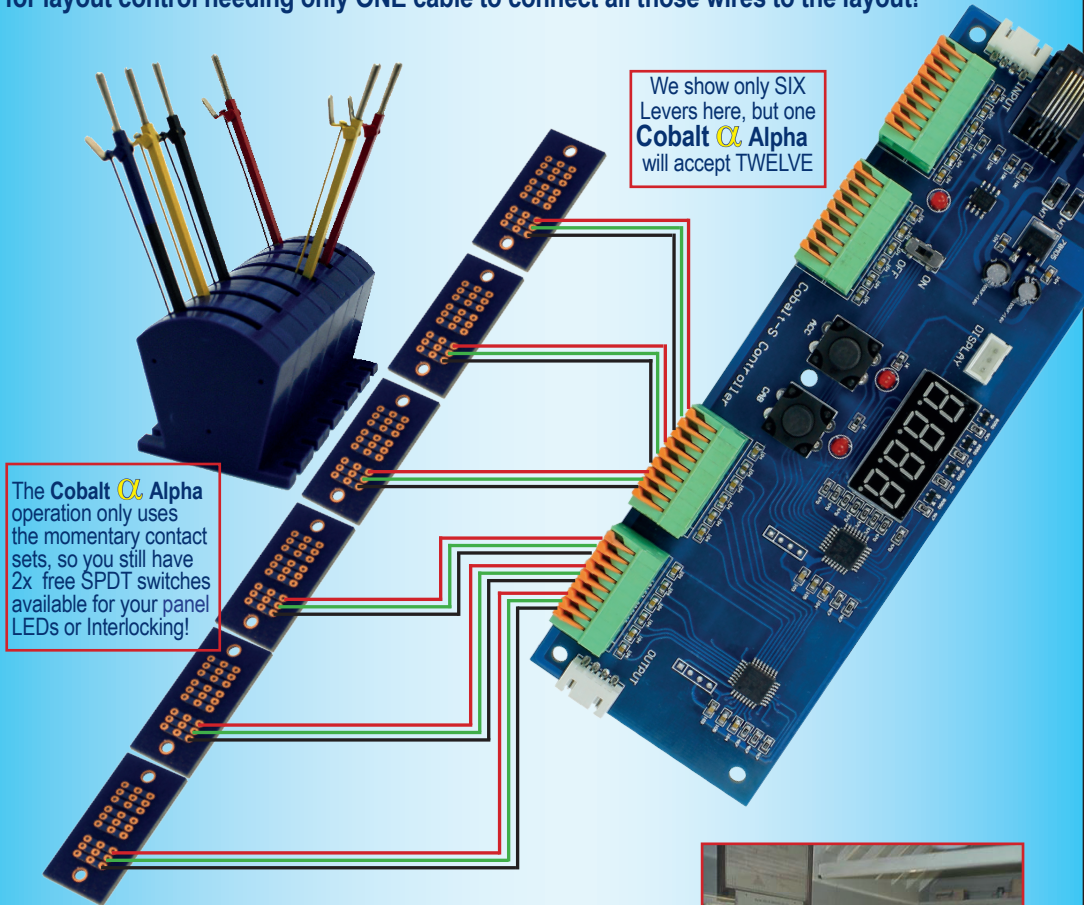

The Cobalt α Alpha operation only uses the momentary contact sets, so you still have 2x free SPDT switches available for your panel LEDs or Interlocking!

We show only SIX Levers here, but one Cobalt α Alpha will accept TWELVE

INTERLOCKING LEVER OPERATIONS

It is easier than it sounds... To interlock two levers, just link the momentary contacts of one lever VIA one of the sets of SPDT contacts on another lever, so that the momentary “Change command” for the lever to be “locked” will be sent ONLY if the “Locking lever” is in the Correct position.

This works well with Cobalt-S as the On-On SPDT contacts are changed when the lever reaches around 75% throw and the momentary SPDT only changes at the extreme end of the throw, guaranteeing that the combined 2-lever operations work reliably.

No matter how you wire The Cobalt-S levers, utilising Cobalt α Alpha in the control panel will mean at least 36 less wires between panel and layout!

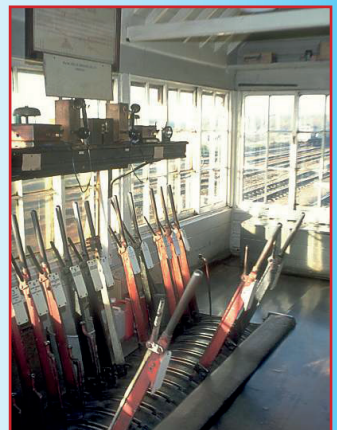

Creating a control Panel using... Cobalt α Alpha & α Alpha Switch-D

Cobalt α Alpha Switch-D is incredibly easy to wire, with every switch having its own 3-wire plug and play lead which simply plugs into the Cobalt α Alpha Switch-D circuit board.

Combining it with Cobalt α Alpha adds the magic of digital technology to greatly reduce wiring... So that your entire control panel needs only ONE plug-in RJ12 cable to connect it to the layout!

It just doesn't get any easier than that



Create, print & laminate the track diagram, then use it as a template to create the panel face.



Use a 6~7mm hole punch to cut out the switch holes in the track diagram.
(these are available at most hardware stores)



Using the diagram as a template, draw around the holes to transfer them to the panel face.
Drill carefully and carefully clean up the holes.



Once its all tidy, paint the panel on both sides.
This is quite important as adhesives will work better on a sealed surface. Let it dry completely!

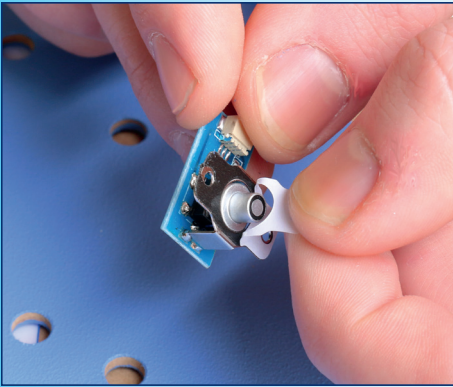

Carefully peel off the protective layer from the switch mounting pad to make it ready to mount

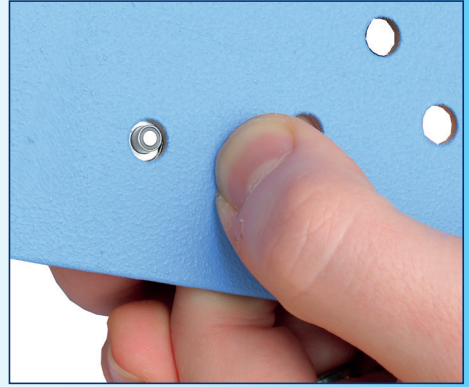

Fix the switch to the panel with the mounting pad. Centre it carefully please! (Using the Bezel as a guide will help you to centre it)

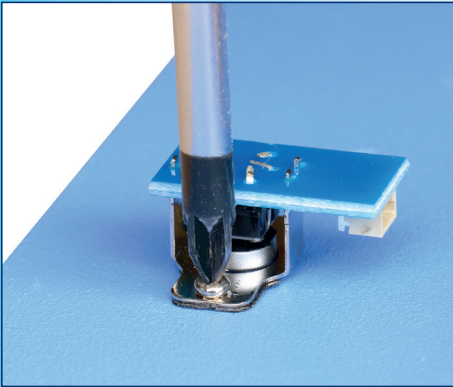

Now carefully screw each of the switches in place (You do not need to over-tighten). They can go at any angle where space is tight





Once all of the switches are fixed, then use 3M Permanent Spray Glue to neatly fix the diagram to the panel face. (be careful to position it well)

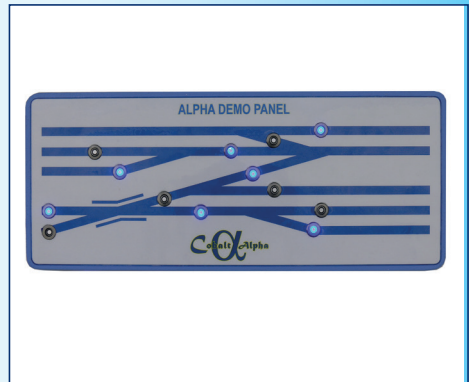

Add the turned aluminium trim collars. Use just a little silicone or glue to do this. Press in place.



All that you now need to do is plug the switches into the panel and connect the Cobalt  Alpha Switch-D circuit board to your Cobalt  Alpha unit

Cobalt α Alpha and Cobalt α Box (Accessories)

Cobalt α box interfaces with EVERY DCC BRAND using only the track outputs of your DCC system. System connection may require accessories such as connection panels, leads and additional cables. While the various DCC brands may supply some of them, DCCconcepts also offer a range of unique items properly designed for Cobalt Alpha products. Additionally, some items that are useful for other brands are unique, such as the convenient 6-wire curly cord for the NCE PowerCab and the very useful, versatile 3-connection Alpha-Panel which is equally usable for NCE PowerCab or Power Pro systems.

Please note:

Check the system diagrams carefully before connection. Do NOT attempt connection without adapters, even if your system seems to have the same sort of connector, as incorrect connection will almost certainly cause easily identifiable related damage that will **NOT** be covered by warranty!

(Please note: The images used on this page are representative only and the items that you receive may look a little different)



6 foot (1.7m) 6-wire Curly Cord, DCD-ACL

While each Cobalt α box and Cobalt α Central is supplied with one, there is always a need for more... and NCE PowerCab users will be delighted to replace their flat cord with this cable as it is FAR more convenient!

Please: Use **ONLY** this cord or its equivalent to connect between multiple Cobalt α box units!

Universal RJ 12 Layout Panel, DCD-DAP

Cobalt α box and Cobalt α Central users will find this panel helpful as it gives all of the connection they will need.

We made this panel really versatile so this one panel type suits both NCE PowerCab and NCE Power Pro users thanks to a single switch on the rear PCB! We also added three RJ12 connection points where most only give two to increase connection potential.

Set the onboard switch to the PowerCab position and the Left hand socket becomes the "PowerCab Port.... With it's LED glowing BLUE when the PowerCab finishes its "Boot" sequence.

Set it to the Universal position and that same socket becomes a standard RJ12 socket for connection of a Procab, a PowerCab in "Procab mode" or any other NCE handset and the LED will now glow GREEN when the bus is operational - as will the other two sockets on the panel.

Of course... As the panel is fitted with RJ12 sockets, with all 6 wired, they are also usable with ROCO and some others DCC systems!

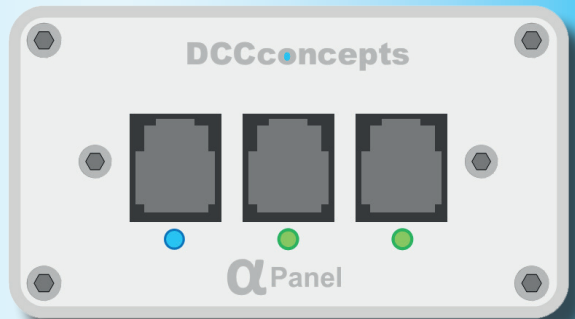

PLEASE NOTE: In some cases, the images used in this manual are of prototype or pre-production units and may vary slightly in appearance from those actually on sale. However in all cases all of the connections and diagrams are identical and the information given is correct.

Cobalt α Alpha and Cobalt α Box (DCC System Adapter leads)

Cobalt α box interfaces with EVERY DCC BRAND using only the track outputs of your DCC system, however if you want to integrate Cobalt α box into the control bus, you will need some adapter leads. There are TWO types of lead, one for the DCC system control box interface and one for the addition of Handsets and related items such as "Connection panels". We have packed the adapters in sets of 3, with 1x main system box, 2x handset/other per pack.

Please note: NCE users will not need adapters for full system integration... but other brands often will. Please check the system diagrams carefully before connection. Do NOT attempt to make your own unless you are VERY confident in your ability. Do NOT attempt connection without the correct adapters, even if your system seems to have the same sort of connector, as even momentary incorrect connection will almost certainly cause easily identifiable related damage that will **NOT** be covered by warranty!

(Please note: The images used on this page are representative only and the items that you receive may look a little different)



Adapters are labelled for each brand

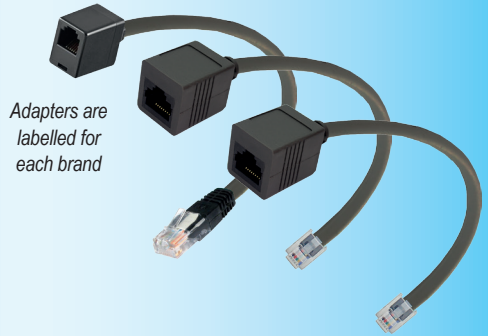

Adapters are labelled for each brand

LENZ Adapter Set. DCD-LNZ

Adapters for LENZ. 1x Base station (Male DIN to Female RJ12) and 2x Handset/Bus adapters (Female DIN to Male RJ12)

Gaugemaster/MRC Adapter Set. DCD-GMP

Adapters for GM Prodigy/Express and MRC. 1x Base station (Male RJ45 to Female RJ12) and 2x Handset/Bus adapters (Female RJ45 to Fem. RJ12)

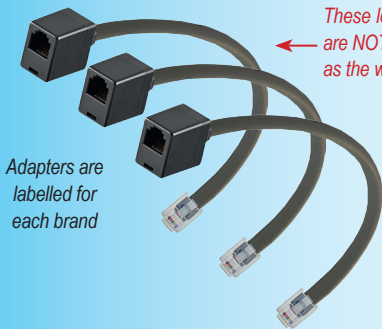

Adapters are labelled for each brand

← These look the same but are NOT interchangeable as the wiring is different →

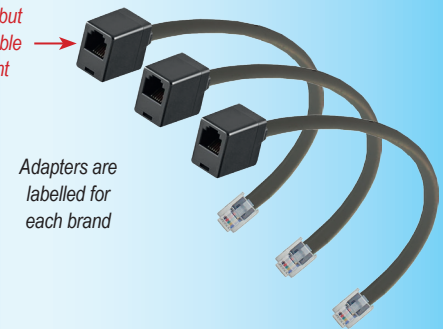

Adapters are labelled for each brand

ROCO Maus & Z21 X-bus Adapter Set. DCD-RCO
Adapters for ROCO One Base station (Male RJ12 to Female RJ12) and Two Handset/Bus adapters (Female RJ12 to Male RJ12)

DIGITRAX Adapter Set. DCD-DGX Adapters for DIGITRAX One Base station (Male RJ12 to Female RJ12) and Two Handset/Bus adapters (Female RJ12 to Male RJ12)

Cobalt α Alpha

Making control panel creation wire-free & easy

The Cobalt α Alpha Encoder is the perfect companion for our 3-wire Alpha Switches

DCCconcepts Cobalt α Alpha is a digital encoder that turns any form of switch into a digital device, making it possible to create control panels with much simpler wiring... in most cases, even complex panels need only a single cable to connect to the layout!

DCCconcepts Cobalt α Alpha is usable by all modellers in all major scales, whether you drive the trains with AC, DC or DCC power.

What is needed? Cobalt α Alpha is directly connectable to the command bus of all NCE DCC systems with a 6-wire RJ12 cable.

Add the Cobalt "Cobalt α box" and AC or DC modellers OR users of ANY DCC BRAND can immediately take advantage of Cobalt Alpha to reduce their control panel complexity. (DCC can be connected directly with from track output terminals, Bus extensions may need adapters).

How does it connect? If you have a DC or AC powered layout you need NO change to controllers or locos at all, but you will need to add a DCC-standards based accessory decoder to each turnout or each active accessory you wish to control - and create a accessory power bus.

You will also need the "Alpha α box". All DCC users can also use the "Alpha α box" ...it is the base unit for a DCC Accessory power bus. Alpha Box also becomes an ideal upgrade for those needing more power and ANY BRAND of DCC system will work with Alpha α Box.

Note: NCE PowerCab users can also use Alpha α Box to increase the power and performance of Powercab to that of a full 5 amp system.

If you have another brand of DCC system ...you can use Cobalt α Alpha too. Either by simple track power connection or, as a full system bus addition with the addition of an appropriate "Adapter leads".

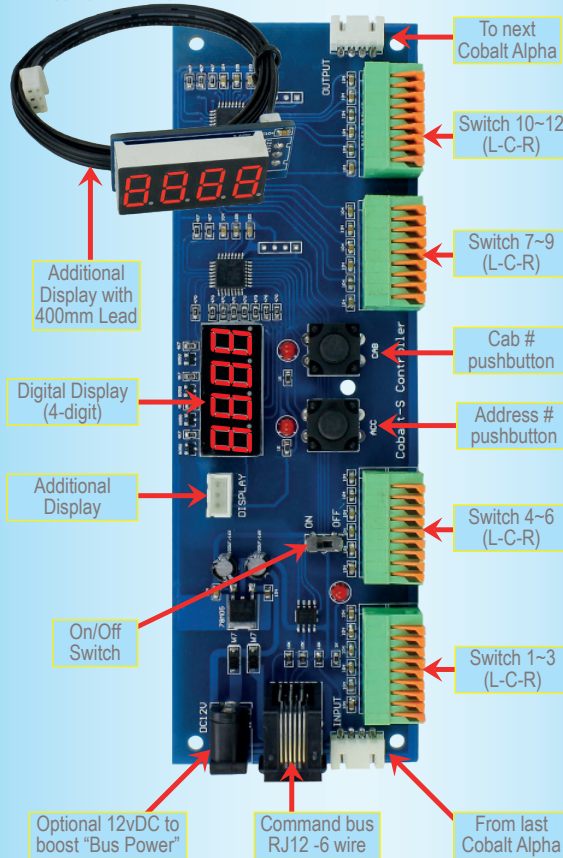

PLEASE NOTE: In some cases, the images used in this manual are of prototype or pre-production units and may vary slightly in appearance from those actually on sale. However in all cases all of the connections and diagrams are identical and the information given is correct.

Cobalt Ω (omega) Point Motor

The successor to the original Cobalt, Cobalt Ω looks familiar but it has been totally re-tooled inside and out to make Cobalt Ω even better.

Cobalt Ω may look the same as before... but Cobalt Ω has a revised internal gear structure, is even quieter than its predecessor and now features THREE on-board SPDT switches for extreme versatility.

We have also added a simple to use voltage range-change switch giving you totally reliable performance over a very wide power supply choice (We like to operate at 9v, but really anywhere from 6~18 volts DC is just fine).

Current users of Cobalt motors will find the Cobalt Ω operates in total harmony with their existing Cobalt motors. The only significant wiring change being the position of the connections. These are now moved to terminals 1 and 2 (same as Cobalt iP and iP Digital) to keep all "New Generation" Cobalt motors in harmony.

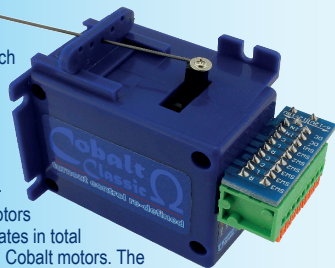

Cobalt iP Analog Point Motor

While the shape is familiar, our Cobalt iP Analog has the same super-quiet operation and 3 on-board switches of Cobalt Ω plus a simple to use "Swap direction" switch to let you synchronise the changing of direction with software / macros or route control.

We have also added something very special inside.... The iP in the Cobalt iP

Analog name means Intelligent power control! Cobalt iP Analog self-manages power use for the same drive speed irrespective of voltage (7~23v is OK).

When it's standing still, Cobalt iP Analog draws only enough power to listen for the next command and even when operating, it draws only 40~60mA. That is in fact less than the current draw of one super bright LED!

Cobalt iP Analog really is the best choice for larger, busy layouts!



Cobalt iP Digital Point Motor - without doubt, the BEST directly DCC connectable motor EVER

Cobalt iP Digital includes all of the features of iP Analog and more!

To allow DCC + full manual control we've added a second set of momentary push button switch contacts for fully independent left/right "change direction" control (instead of 1-button toggled action).

Cobalt iP Digital is comfortable with 7~23v DCC track power and is super-easy to install as it's delivered self-centred and ready to go! Cobalt iP Digital also has three simple-to-use software commands built in.

We've made use of these easy by utilising standard "Address-setting procedures" to activate or deactivate them.

These new software options activate or deactivate the self-centering function and also let you "flip the change direction".

This allows you to synchronise or change operating direction so that it matches

perfectly with track diagrams on screen-based control systems or with any

brand of layout control software, as well as with route control etc.

(It also makes it possible to install Cobalt iP digital facing either the Toe or Heel of the point, so installations in tight places are easier!)

Cobalt Ω AlphaSwitch-A

Connecting Cobalt Omega or iP Analog motors OR Stall-type turnout motors of any brand becomes really easy with Cobalt Ω Alpha Switch A.

The Switches incorporate the LEDs in a very sophisticated way and are simply "plug and play" as each has its own 3-wire lead with push connector, making assembling a panel as easy as playing with Lego!

To complete the wiring, All you will need is a small screwdriver and a wire stripper for the Wires that will connect the outputs to the motors. As you can see, from our "Create a Control Panel" pages its easy! Use a split-rail power supply like DCCconcepts PSU-2 (9+9) or SPS12 (12+12)

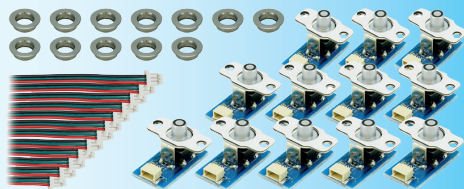
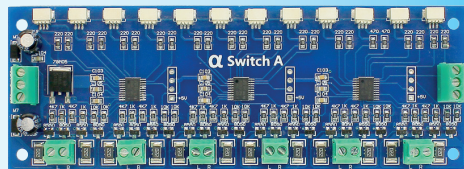

Cobalt Ω AlphaSwitch-D

Control of ANY Digital Accessory and creation of a professional-looking Control panel are really easy with Cobalt Ω Alpha Switch-D as you can see, from our "Create a Control Panel" pages.

The Switches incorporate the LEDs in a very sophisticated way and are simply "plug and play" as each has its own 3-wire lead with push connector, making assembling a panel as easy as playing with Lego! To complete the wiring, or connect it to Cobalt Ω Alpha all you will need is a small screwdriver and a wire stripper for the Wires that will connect the outputs to the motors.

(AlphaSwitch-D has power off memory so it remembers switch positions between operating sessions. Use any regulated DC power supply 9~12volts to power it. Each pack contains control PCB plus 12 switches and all Accessories

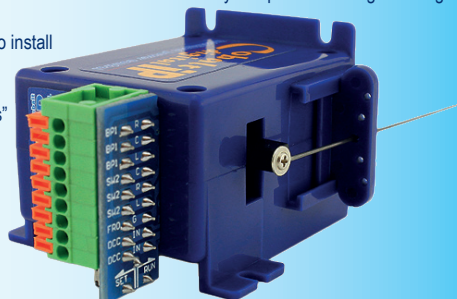

Page intentionally left blank:

Cobalt α Alpha products & Accessories

All DCCconcepts products are available from DCCconcepts, their distributors and retailers across the globe.

Our range is growing and good information is essential so we welcome dealer enquiries from everywhere. We strongly encourage ALL dealerships and resellers to register with the fully secured trade area of our website so that you will gain full access to backup information and “insider” insights!

Warranty and After-service

The DCCconcepts Warranty for Alpha Products is 12 months from date of purchase and DCCconcepts pledge to always maintain good stocks of parts and any related components that may be required for servicing of Alpha products.

Every single item in this range is pre-tested before shipping, however no matter how hard we try perfection is impossible so occasionally, we do accept that a unit may fail.

However please be aware that wrong connection or the use of inappropriate power supplies WILL often cause serious damage. Such damage is NOT covered by warranty.

Customer Service and advice

We have done our best to provide complete information in this manual but we do understand that there will always be questions & so we offer comprehensive support at all times.

Please feel free to email us at Advice@DCCconcepts.com if you have any questions about Cobalt Alpha products and their use. We usually respond within 48 hours.

DCCconcepts Pty Ltd
Units 2~4, 13 Lionel Street
Naval Base WA 6165
AUSTRALIA

Telephone: +61 8 9437 2470
Facsimile: +61 8 9437 2471
Email: sales@dccconcepts.com
Support: advice@dccconcepts.com

www.dccconcepts.com

